

NOVEMBER 1994

DTIC
1994 1 8 1994

NAVY TERRIER LEAP THIRD-STAGE PROPULSION

Accession For	
NTIS CRA&I	<input checked="" type="checkbox"/>
DTIC TAB	<input type="checkbox"/>
Unannounced	<input type="checkbox"/>
Justification	
By	
Dist ID (Dist)	
Availability Codes	
Dist	Avail and/or Special
A-1	

**K. E. OLSEN
J. J. WALSH
E. L. THOMAS**

Presented at
AIAA Missile Sciences Conference
November 7-9, 1994
Monterey, California

19941206 062

UNCLASSIFIED STATEMENT A
Approved for public release;
Distribution Unlimited

Navy Terrier LEAP Third-Stage Propulsion

K. E. Olsen, J. J. Walsh, and E. L. Thomas
Thiokol Corporation/Elkton Division
Elkton, Maryland

Abstract

Under contracts with the Air Force Phillips Laboratory (Edwards Air Force Base, California) and Hughes Missiles Systems Company, the Elkton Division of Thiokol Corporation has completed the design, development, and qualification of a third stage for use in the Ballistic Missile Defense Organization (BMDO)/Navy Terrier Lightweight Exoatmospheric Projectile (LEAP) flight experiments. The stage consists of a solid-propellant motor with omni-axis thrust vector control (TVC), safe-and-arm (S&A) devices, flight-termination system, pitch/yaw/roll attitude control system (ACS), cables/connectors, and skirt/interstage structures. The motor with these components is designated as the advanced solid axial stage (ASAS).

This paper describes the design, requirements, and results of component- and system-level testing to qualify the stage for the flight tests (FTV-3 and FTV-4) scheduled for December 1994 - January 1995.

Introduction

Several interceptor (booster and kinetic kill vehicle [KKV]) approaches are being studied for application to the Aegis-based Navy Wide-Area Defense System. One candidate being considered for the upper-tier mission is a Block IV Standard Missile (ER 72 + Mk 104) payload/warhead. To demonstrate the feasibility of this approach, an advanced technology demonstration (ATD) flight experiment program was put in place by the BMDO and Navy. The program is based on the use of the Terrier launch platform, Standard Missile II Block IV missile, an ASAS third stage, and a Hughes Missile Systems Company (FTV-3) and Rockwell (FTV-4) KKV. To support this program, the Elkton Division of Thiokol Corporation used technology developed under the ASAS program for the Air Force Phillips Laboratory to design, develop, manufacture, and qualify an axial kick stage (AKS) for use as the third stage. Also, under contract with

Hughes Missile Systems Company/Pomona Division (HMSC/P), Elkton designed and qualified a third-stage ACS.

The Advanced Solid Axial Stage (ASAS) development program has had two objectives under the sponsorship of the USAF Phillips Laboratory and the Ballistic Missile Defense Organization (BMDO). The initial program objective, at its inception in 1988, was to provide the first-stage propulsion for a space-based interceptor as part of the Strategic Defense Initiative (SDI). In achieving this objective, achievements included development of high- I_{sp} propellants, improvement in component mass fraction, and demonstration of flexseal scalability for thrust vector control (TVC). This development continued through 1991 and in 1992, the program was redirected to provide the third-stage propulsion for the Navy Terrier (Lightweight Exo-Atmospheric Projectile) LEAP flight experiments (Fig. 1).

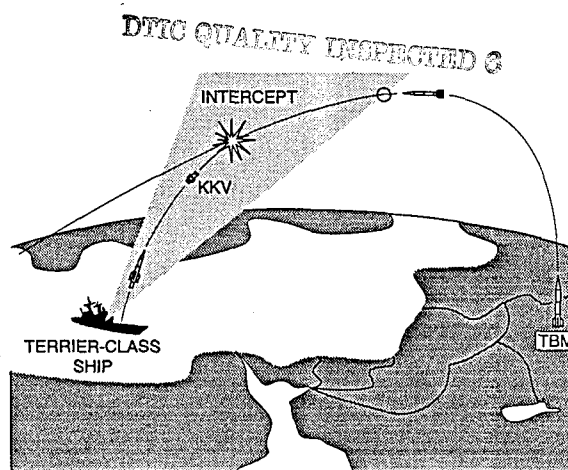

Figure 1. Navy Terrier LEAP Mission

There were three objectives for the ASAS in support of the Navy Terrier LEAP mission. The ASAS program was to maximize performance while maintaining low technical risk and to conform to a specified envelope. The ASAS had to be qualified for flight in the Standard Missile warhead section. Specifically, the ASAS program

had to design and integrate the stage components for the flight experiments. The stage (Figs. 2 and 3) consists of the ASAS rocket motor, initiation system, flight-termination system, and a hybrid (warm-gas/cold-gas) attitude control system.

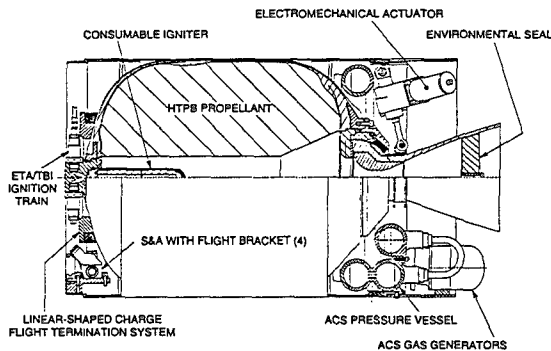

Figure 2. ASAS Cross Section

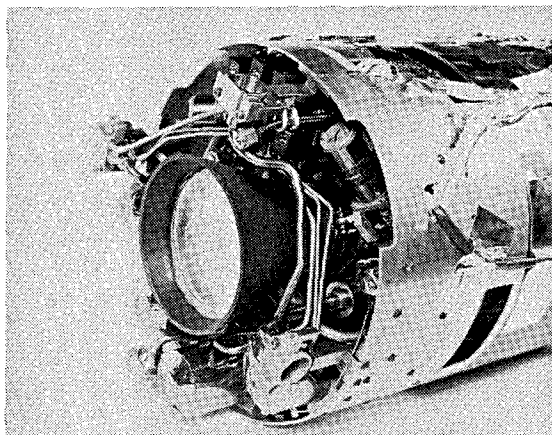

Figure 3. Integrated Advanced Solid Axial Stage (ASAS)

The ASAS 12.5-in.-diameter by 22-in.-long case is graphite epoxy composite wound over a mandrel. Approximately 72 lbm of solid propellant is cast net into the case. The aluminized, hydroxyl terminated polybutadine (HTPB) propellant is a proven Thiokol/Elkton space motor formulation. The motor operates at a maximum pressure of 2000 psi, providing an average thrust of approximately 1600 lbf. The case has composite skirts and aluminum end rings that interface with the Standard Missile on the forward end. The ASAS is cantilevered from the forward end and an external shroud couples the ASAS to the Standard Missile second stage.

ASAS has a 5° omniaxis thrust vector control system consisting of a flexseal nozzle, electromechanical (EM) actuators, digital controller, and a thermal battery. The Terrier LEAP application mounts the TVC controller and thermal battery in the guidance section, forward of the ASAS. The actuators, supplied by AlliedSignal Aerospace Systems and Equipment, provide thrust vectoring at greater than 50° per second slew rate. The digital controller contains a hybrid H-bridge and uses RS-422 communication protocol. A thermal battery provides electric current to the TVC controller for a minimum of 40 seconds.

The ASAS redundant ignition system is initiated by an electric pulse to a safe-and-arm device (SAD) (Fig. 4), activating a detonator, which initiates an explosive transfer assembly (ETA). The ETA ignites a through-bulkhead initiator (TBI). The output of the TBI ignites a consumable pyrogen igniter mounted in the head end of the ASAS. The flight-termination system (FTS) is also initiated by SADs and ETAs. The FTS consists of a linear-shaped charge (LSC) that is configured in a 320 degree arc around the forward polar boss. Upon initiation, the LSC cuts a 5-in.-diameter hole in the forward dome of the motor, immediately neutralizing any thrust if the motor was operating. Both the FTS and SADs have been qualified to levels greater than those required for operational Standard Missile qualification because these components are considered safety-critical. Temperature extremes were 20° greater while shock and vibration levels were 20 dB and 6 dB, respectively, over those required for Standard Missile.

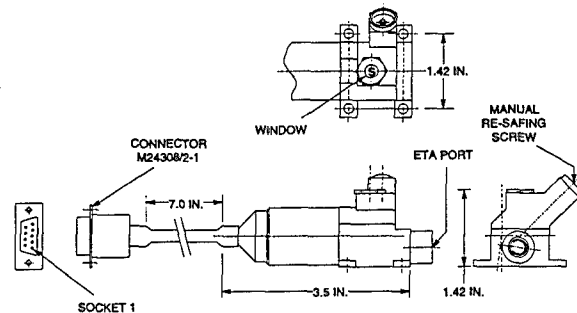

Figure 4. Safe-and-Arm Device

An attitude control system (ACS) has been integrated into the aft end of the ASAS and provides pitch, yaw, and roll control to the Navy Terrier LEAP third stage after separation from the second stage. The ACS is a hybrid design, incorporating low-thrust cold-gas ACS and a high-thrust warm-gas ACS as an integral system. The ACS had to be packaged within the 12.5-in.-diameter aft end of the ASAS, while allowing for adequate volume for TVC actuators and $\pm 5^\circ$ omniaxis movement of the nozzle. The toroidal cold-gas storage vessels are mounted under the actuators and attached to the case end ring. The balance of the ACS is mounted to an interstage ring that is attached to the aft face of the end ring. A two-piece end ring/interstage ring design was required for assembly of the system.

Once the ASAS/ACS assembly is complete and all electrical cables are routed along the side of the motor to the forward end, the third-stage shroud is installed. The shroud attaches to the ASAS on the forward end, such that the ASAS is cantilevered within the shroud. All wiring is routed in the gap between the shroud and the ASAS. Once the ASAS/ACS is installed in the shroud, it is ready for integration with the remainder of the missile.

The ASAS has completed a five-motor test program (Table I) as qualification for flight on the Navy Terrier LEAP flight experiments. The ASAS went through the series of tests, which included an increasing amount of environmental testing as the test series progressed. The final static test, designated AKS-4 (axial kick stage - 4), included 10-day temperature and humidity cycling, transportation vibration, flight vibration, and first-stage ignition shock. Throughout the environmental testing and the static test of AKS-4 (Fig. 5), the ACS, FTS, and TVC (without controller and thermal battery) systems were fully integrated with the ASAS, and no problems were encountered. With qualification testing complete and successful for the ASAS, it is ready for flight on the Navy Terrier LEAP flight experiments.

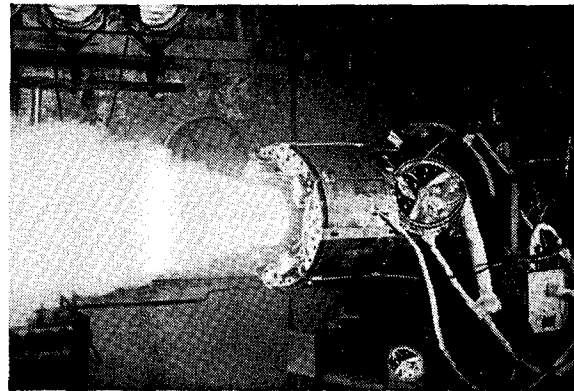

Figure 5. AKS-4 Static Test

Attitude Control System

In mid-March 1993, Thiokol was placed under contract by Hughes Missile Systems Company/Pomona Division (HMSC/P) to design, develop, and qualify an attitude control system (ACS) to be packaged on the aft end of the ASAS motor. The ASAS motor with ACS was to be developed and qualified for use as a third stage of the BMDO/Navy Terrier LEAP flight experiment vehicle. The ACS (Fig. 6) is a unique hybrid warm-gas/cold-gas system that provides attitude control and maneuvering capability for the Terrier LEAP third stage. A hybrid ACS was selected to best meet requirements of the Terrier LEAP mission profile shown in Figure 7. This profile includes three short-duration high-thrust ACS periods, which are best met by the warm-gas ACS subsystem and intervening, long periods requiring low thrust, which are best met by the cold-gas ACS subsystem. The work has been accomplished on a very aggressive schedule; breadboard tests of the warm- and cold-gas subsystem (Fig. 8) were conducted within 7 months of program start, first qualification test within a year of program start, and first flight unit delivery within 14 months of program start. This program has positioned Thiokol to provide ACS for a wide range of mission requirements within relatively short time frames and at low program risk. Demonstration of a hybrid warm-/cold-gas system enables Thiokol to provide either an all warm gas, all cold gas, or hybrid ACS, depending on which best meets mission requirements and at no increased risk.

Table I. Motor Test Comparison

	AKS-1	AKS-2	AKS-3	AKS-3A	AKS-4
Test date	7/31/92	10/22/92	4/20/93	12/16/94	7/19/94
Test temp, °F	70	40	95	70	70
Sea level/altitude	Sea level	Altitude	Altitude	Altitude	Sea level
Environments	None	Temperature cycling	Vibration and shock	Vibration, shock, temp and humidity (4-day)	Temp and humidity cycling (10-day), acceleration, vibration, and shock
Motor support	Front/aft end	Front/aft end	Front only	Front only	Front only
Actuator	Heavyweight	Heavyweight	Flightweight	Flightweight	Flightweight
Controller	Breadboard	Breadboard	Flightweight	Flightweight	Flightweight
Controller power	Facility	Facility	Thermal battery	Facility	Thermal battery
S&A devices	None	None	Development units	None	Qualified units
Flight-termination system	None	None	Yes (inert)	No	Yes (live)
Attitude control system	None	None	Gas generator simulators	Gas generator simulators	Yes (operation posttest)

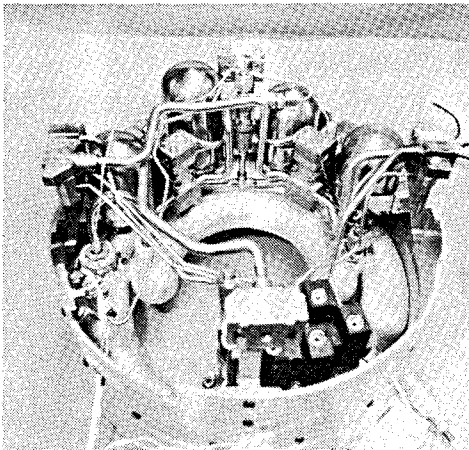

- Selected a unique warm-/cold-gas hybrid for Terrier LEAP for increased performance margins
- Hybrid is Terrier LEAP flight-qualified
- Preliminary studies indicate that only minor modifications are required for an Aegis-based configuration

Figure 6. Terrier LEAP Hybrid ACS

The hybrid ACS (Fig. 7) combines both warm-gas and cold-gas subsystems, which are designed to provide stage attitude control and maneuvering. The cold-gas system provides roll control and low-level pitch and yaw maneuvering with the cold gas supplied from a 10-Ksia Gr₂ toroidal pressure vessel. The warm-gas system provides for high-level pitch and yaw maneuvers with the warm gas supplied from three solid propellant gas generators. A fourth gas generator provides redundancy/backup, if necessary.

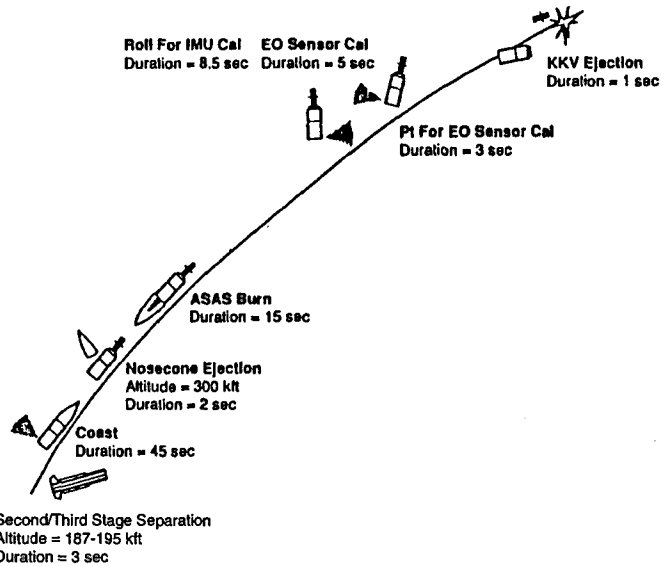

Event	Hybrid ACS	
	Warm-Gas	Cold-Gas
• Point to LOS for KKV eject	0	2.8
• Roll for IMU cal	0	2.6
• Point for EO sensor cal	17.0	2.7
• ASAS burn	0	2.5
• Nose cone ejection	7.0	8.0
• Coast	0	8.6
• Separation	40.0	1.3
Total	64.0	28.5
Margin (40%)	25.6	11.4
Requirement, lbf-sec	89.6	39.9

Figure 7. Flight Test Vehicle Design (Performance Requirement Per Event)

Cold-Gas System (CGS)

Features of the cold-gas system include the following:

A cold-gas storage system consisting of a full and two partial toroid subassemblies. The subassemblies are mechanically connected via a high-pressure crossover tube and share a common manifold during operation. The storage system is filled to 10,000 psi with GN₂.

A pyrotechnic isolation pressure vessel closure with redundant electroexplosive devices.

Two pressure transducers, one upstream and one downstream of the pressure vessel closure.

Cold-gas valves, nozzles, and associated manifolding to provide pitch, yaw, and roll control forces.

One regulator assembly to control gas flow from the high-pressure bottles to the cold-gas thruster valves and warm-gas pilot valves.

One relief valve in the cold-gas manifold downstream of the regulator to prevent over-pressurization of the cold-gas manifold-thruster assembly.

Warm-Gas System (WGS)

Features of the warm-gas system include the following:

Four solid-propellant gas generators with squibs and outlet port burst disk.

Manifold and associated tubing to transport warm gas from the gas generators to each warm-gas thruster valve.

One each pitch and yaw thruster valve and four warm-gas nozzles (one each positive and negative yaw and pitch) and associated manifolding to transport gas from the valves to the nozzles.

Two pilot valve assemblies (driven by cold gas) and associated plumbing to control pitch and yaw warm-gas thruster valve operation.

One pilot valve shutoff to open flow to the pilot valves during warm-gas operation.

One pressure transducer downstream of the pilot valve shutoff valve.

One ground test port to permit cold-gas functioning of the warm-gas subsystem for checkout and test.

Two redundant pressure transducers in the warm-gas manifold.

The challenge of completing the first flight delivery within 14 months of program start was satisfied by following a carefully planned series of activities. The sequence of activities (Fig. 9) began with component/system design, then component-level testing (such as component performance characterization, warm-gas/valve material compatibility, etc.), subsystem breadboard testing, static system qualification test (no environments), dynamic system qualification/air bearing test (no environments), static system qualification test (with environmental exposure on ASAS). The more significant tests in this series are listed in Table II. These tests on components, subsystems, and systems provided a minimized risk approach to system qualification. Component level and breadboard testing served as the basis for establishing acceptance test methods and criteria to be used for the qualification and flight units. These will serve as a foundation for defining acceptance tests for future systems that may be required to meet various TMD requirements.

The integration process was recognized at the onset as one of the critical challenges. A process was defined to develop the process in phases beginning with 3D system modeling, then component mockups, breadboard subsystem, inert system, qualification system units, and flight units. The process allowed resolution of potential interface/packaging problems in a timely manner to minimize potential impacts.

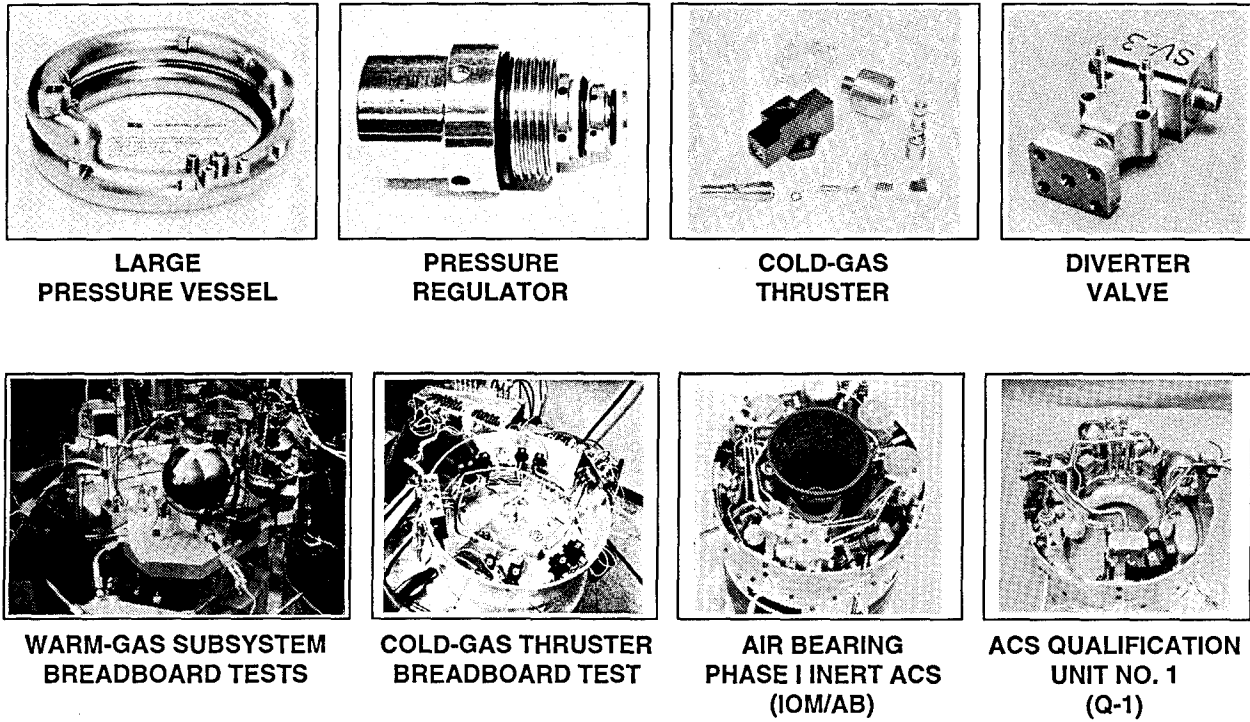

Figure 8. ACS Components and Development Testing

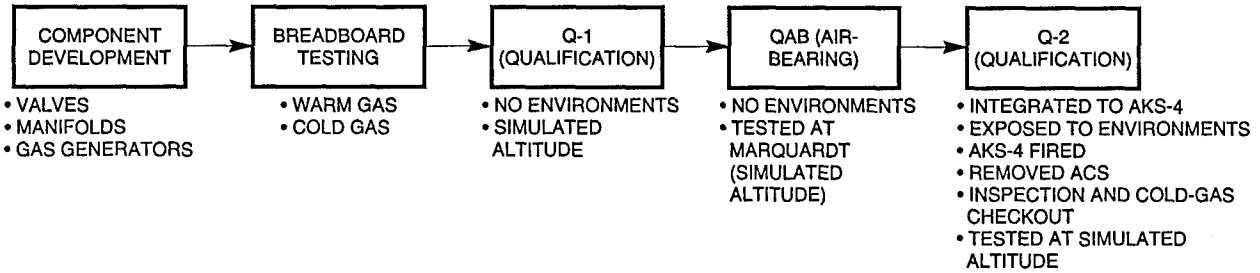

Figure 9. ACS Development

Conclusion

Thiokol, working in conjunction with the Terrier LEAP community, has successfully designed, developed, and qualified a third-stage propulsion system (Fig. 10) for use on the Terrier LEAP program. Extensive testing has been conducted to verify compliance to stage requirements prior to flight testing. This technology is applicable to future missions requiring axial propulsion as well as pitch, yaw, and roll control and has been demonstrated by Thiokol.

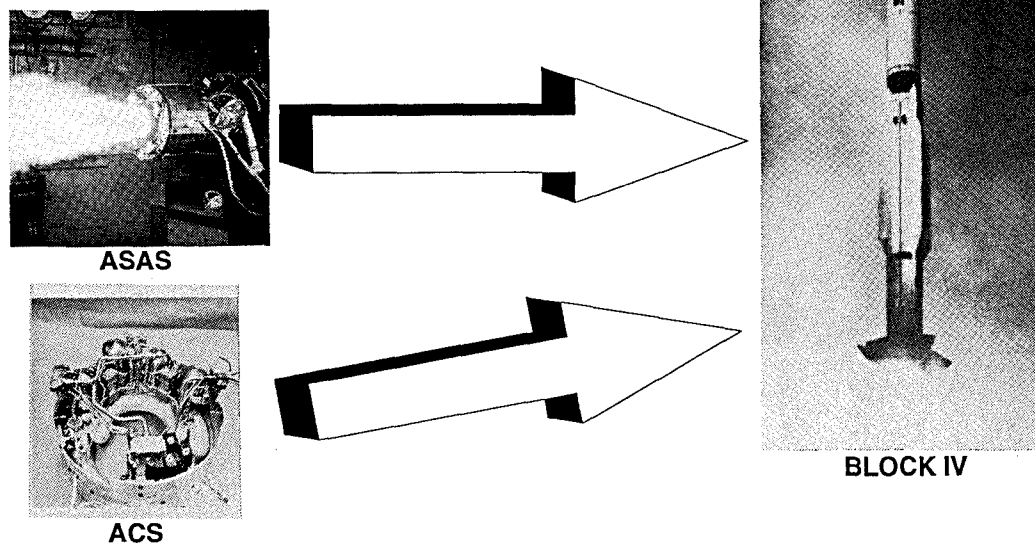

Figure 10. ASAS and ACS Support Terrier LEAP Flight Experiments

Table II. Component/System Development/Qualification Tests

ACS	Material compatibility, 4 gas generator burns each test	2	Development
ACS	Operational selector valve test, 4 gas generator burns each test	2	Development
ACS	Manifold flow loss test, 4 gas generator burns each test	1	Development
ACS	Warm-gas breadboard test, 4 gas generator burns each test	2	Development
ACS gas generator	1.25 x MEOP burst test	1 each gas generator configuration	Development (design margins)
ACS	Cold-gas breadboard test	1	Development
ACS	Cold-gas plume impingement, altitude	1	Development
Cold-gas storage bottle	Burst test (2.0 x MEOP)	1	Development
Cold-gas storage bottle	Fill cycle	3	Development
ACS	Static test, altitude	2	Qualification
ACS	Static test, altitude air-bearing stand	1	Qualification